

HP Universal Database rješenje s DL580 i HP 3PAR  
StoreServ 7450 All-Flash-Array poljem



Dr.sc. Draško Tomić  
HP Chief Technologist  
HP Server Ambassador



# Agenda

- Osnovne značajke rješenja
- Analiza performansi
- Video
- Q/A



## Osnovne značajke rješenja



IT odjeli su pod stalnim pritiskom kako bi:

- proizveli dodatnu poslovnu vrijednost
- poboljšali postojeću infrastrukturu
- iskoristili prilike za dodatni rast
- smanjili troškove

Porast transakcijskih podataka uvjetuje:

- povećanje performansi i raspoloživosti baza podataka
- velike brzine obrade podataka i mala vremena odziva
- prihvat novih storage tehnologija



## Ključne komponente rješenja – HP ProLiant DL580 Gen8 poslužitelj



### HP ProLiant DL580 Gen8 poslužitelj – glavne značajke

- poslužitelj sa četiri utora (4S) dizajniran za visoke performanse, efikasnost i pouzdanost
- sa jedinstvenim svojstvima kao HP Advanced Error Recovery i HP Memory Quarantine
- proširiv do četiri Intel® Xeon® E7 4800/8800 v2 procesora i 6 TB memorije
- devet full length/full height PCI Express (PCIe) Gen3 utora
- podrška za Non-Uniform Memory Arhitekturu (NUMA)



# Ključne komponente rješenja – HP 3PAR 7450 All-flash Storage Array



## HP 3PAR StoreServ 7450 All-flash Storage Array – glavne značajke

- All-flash storage array sa mesh-active arhitekturom, fine-grained virtualizacijom i system-wide stripingom
- Namjenski HP 3PAR StoreServ ASIC omogućava adaptivno čitanje i cache offload kod pisanja
  - Multi-tenant I/O procesiranje poboljšava performanse za slučaj istovremenih različitih poslove (mixed workloads)
  - cijepanje velikih I/O blokova u manje cjeline (chunkove) dodatno povećava brzinu zapisa
- HP 3PAR Persistent Cache zadržava zadane nivoe usluga (Service Level Agreements)
- HP 3PAR Persistent portovi omogućavaju nadogradnju sustava bez zastoja u njegovom radu
- HP 3PAR Peer Persistence pruža mogućnost povezivanja više storage polja u jedinstvenu cjelinu (federative storage systems)
- HP 3PAR StoreServ Data at Rest Encryption štiti podatke
- Flash-based rekonstrukcija greške na mediju
- HP 3PAR Remote Copy softver
- 900.000 IOPS sa < 0.7  $\mu$ s latencijom



## Glavne značajke rješenja



Parametar	Vrijednost
IOPS	1M – 4K read
Iskoristivi kapacitet	26.8 TB RAID5—400 GB MLC drive. 2 x HP 3PAR StoreServ 7450 sa 48 SSD —96 diskova
Storage HA	Da —redundantni storage nodovi i RAID zaštita
Server HA bez degradacije performansi	Da - redundancija serverskih komponenti + ServiceGuard
Kopija baze podataka	Da – 3PAR Remote Copy ili DataGuard
Disaster recovery	Da
Query standby database	Da (Remote Copy)
Database storage	All flash
Volume snapshot	Da
Storage thin provisioning	Da



## Specifične značajke rješenja

Parametar	Vrijednost
Integrirano Oracle backup rješenje	Da
Dinamička optimizacija	Da
Jednostavno upravljanje	Open IT alati
Podržani operacijski sustavi	RHEL, SUSE Linux, Oracle Linux, Microsoft® Windows®
Podržane baze podataka	Fleksibilnot za druge baze, testirano sa Oracle 12c uz ASM na Grid Infrastrukturi.

## Opcije za visoku raspoloživost



Na raspoloaganju je nekoliko opcija:

- HP Serviceguard for Linux klastering softver
- Disaster Recovery rješenje sa HP 3PAR Remote Copy ili Oracle Data Guard
- Oracle Real Application Clusters (RAC)
- VMware vSphere High Availability
- VMware vSphere vMotion





# HP ServiceGuard for Linux option

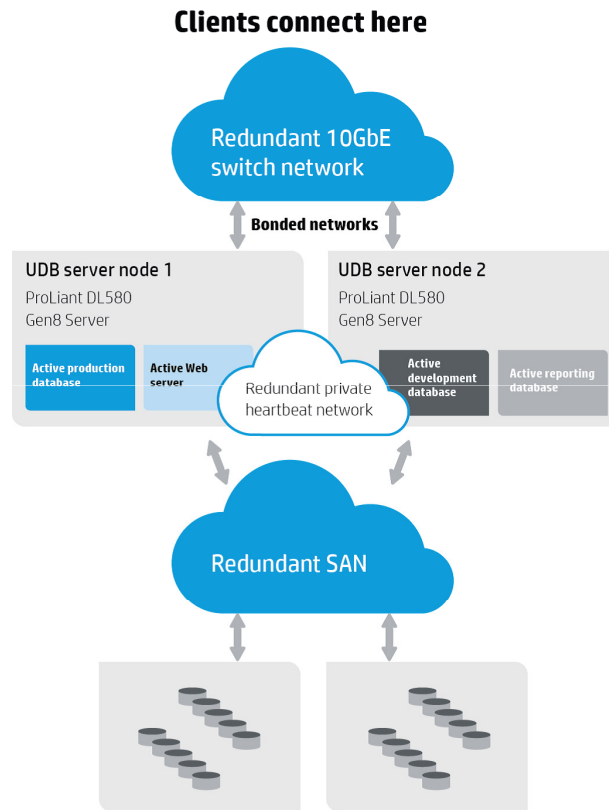

Database	Active node	Standby node
Production	Node 1	Node 2
Web server	Node 1	Node 2
Development	Node 2	None
Reporting	Node 2	Optional

- Application only active on one node at a time
- Upon node failure, application can move to standby server
- Performance must be considered in deciding whether applications share CPU on fail-over, or whether non-critical applications just get shut down (e.g., development system non-critical)

#### HP 7450 Storage arrays

- Multiple database storage groups
- Each database shared with nodes
- Flexibility to set RAID according to performance and capacity needs on a per database basis
- Completely redundant storage

# Disaster Recovery rješenje sa HP 3PAR Remote Copy

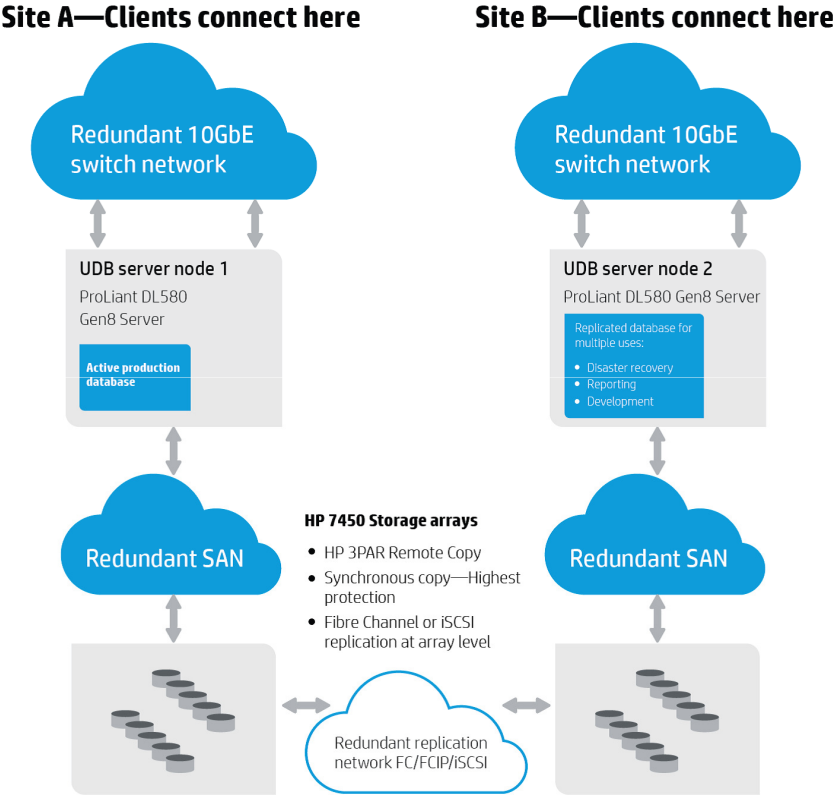

# Reference architecture rack diagram



- 2 x HP ProLiant DL580 Gen8 Servers each with:**
- 4 x Intel Xeon E7-4890 v2 processors
  - 96 x 32 GB DIMMs (1.5 TB memory)
  - 8 x 8 Gbps 2P FC HBA per server
  - RHEL 6.5
  - Oracle 12c Enterprise Edition
- For virtualized Oracle: 60 vCPUs and 1 TB memory

- 2 x HP 3PAR 7450 four-node storage array**
- 4 x drive shelves (Including the controller node pairs)
  - 96 x 100 GB SLC SSD
  - 48 x SSD drives per 7450 array
  - 9.6 TB as configured



HP SN 6000B SAN switches

HP ProLiant DL580 Gen8 Servers

7,000 service processors

7,450—four-node StoreServ controllers



# Testni okoliš

## Tested configuration

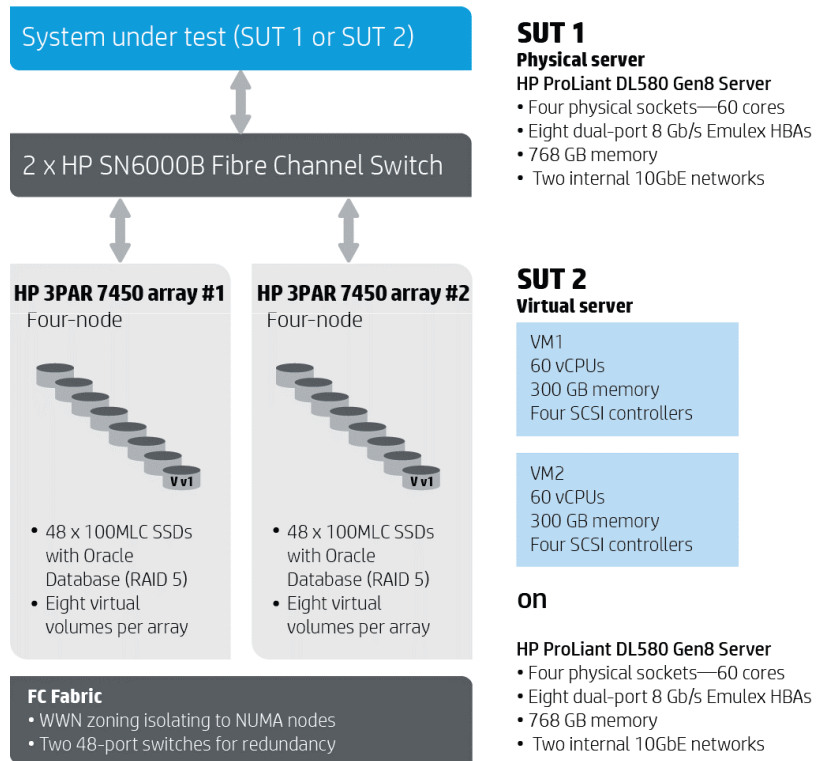

Rješenje daje 1M IOPS u fizičkom i virtualiziranom okolišu, te staje u jedan 42U ormar, sa prostorom za dodatno širenje.



# Shema spajanja

## HP Proliant DL580 Gen9

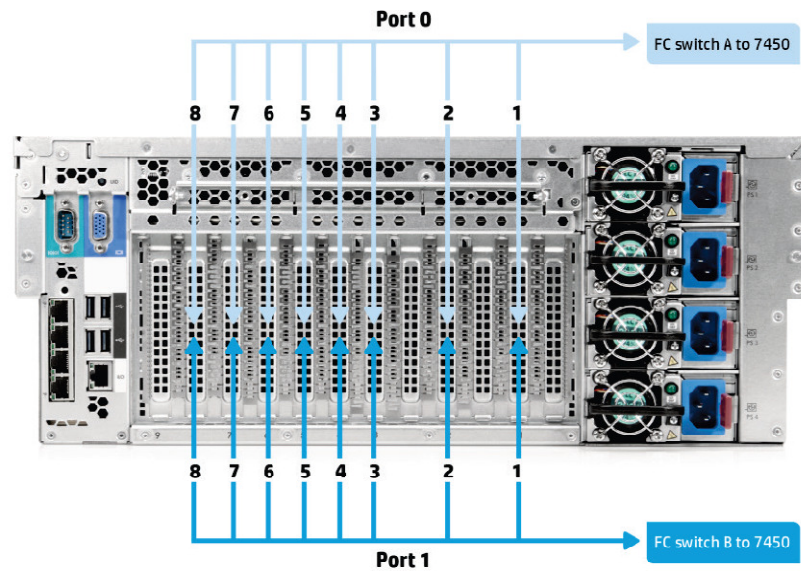

## HP 3PAR 7450 storage array

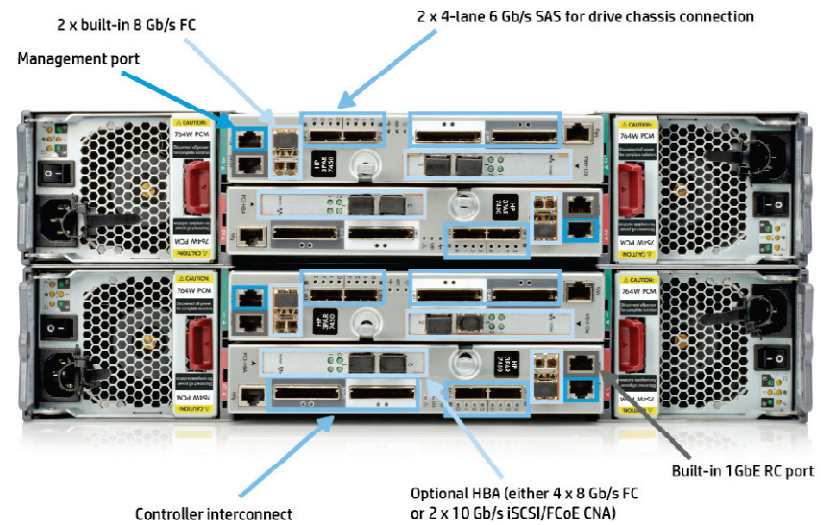

## Analiza performansi



- Minimalan uticaj na performanse među različitim diskovima.
- Propusnost i IOPS su više zavisni od broja 3PAR 7450 sustava u rješenju.
- Dva 3PAR 7450 sustava su potrebna za 1M IOPS i 10 GB/sec propusnost.
- Jedan 3PAR 7450 sustav snižava IOPS i propusnost na pola.
- Dodatni 3PAR sustavi su podržani.
- Jedinstvena ASM disk grupa je korištena za podatke i logove.



## Karakteristike opterećenja



- Svo I/O testiranje je provedeno sa I/O generatorskim alatima sposobnim da proizvedu standardni asinhroni I/O korištenjem Linux libaio knjižnica koje koristi Oracle i drugi vendori.
- Alati su sposobni za simulaciju mnogo različitih opterećenja, istovremeno dopuštajući fleksibilnost u izboru slučajnog ili slijednog pristupa, sa različitim veličinama blokova, repova (queues) i broja niti (threads).
- U našim testovima smo pokazali kako ovo rješenje može dati 1M IOPS za male blokove (4K) kod čitanja.



## Oracle database opterećenja za fizičke i virtualne okoline



- Oracle opterećenje je testirano pomoću HammerDB alata. Alat generira OLTP opterećenje (60% read i 40% write) sa I/O blokovima male veličine.
- Transakcijski rezultati su normalizirani.
- .
- Test suita je odrađena na 1TB bazi podataka, RAID5 polju, i sastojala se od I/O intenzivnih OLTP testova, te od CPU i I/O intenzivnih database testova.
- Testni sustav je optimiran za transakcijsko procesiranje i maksimalnu veličinu baze podataka. Nakon optimiranja baze, transakcije su mjerene varirajući broj simuliranih korisnika. S obzirom da opterećenja znatno variraju u karakteristikama, mjerenja su rađena sa najvećim brojem transakcija.
- U testu je korišten Oracle Enterprise Database 12.1.0.1
- Operacijski sustav: Red Hat Enterprise Linux release 6 update 5.





## Oracle OLTP vršne transakcije za fizičke i virtualizirane okoline



- Oracle test za fizičke i virtualizirane okoline je rađen na OLTP bazi kreiranoj na RAID5 polju.
- Opterećenje je proizvedeno sa CPU i I/O intenzivnim OLTP benchmark alatom koji može dovesti poslužitelj i I/O podsustav u saturaciju.
- Tijekom testiranja, Oracle *init* datoteka je modificirana kako bi se postigao maksimalni broj transakcija i minimalni I/O promet.
- Oracle testiranje za virtualizirani okoliš je rađeno u paraleli na dvije baze podataka, od kojih je svaka bila na svojoj virtualnoj mašini.
- Ove baze su bile identične onoj za fizički okoliš.
- Testiranje je rađeno u paraleli sa obje baze kako bi se simuliralo konsolidirano rješenje na scale-up arhitekturi.



## Oracle parametri

<b>_enable_NUMA_support</b>	<b>TRUE</b>
db_block_size	8192
db_cache_size	322122547200
disk_asynch_io	TRUE
db_file_multiblock_read_count	32
open_cursors	2000
_in_memory_undo	TRUE
_disable_selftune_checkpointing	TRUE
commit_wait	NOWAIT
db_writer_processes	4



# OLTP rezultati za fizičku okolinu

## Normalized transactions

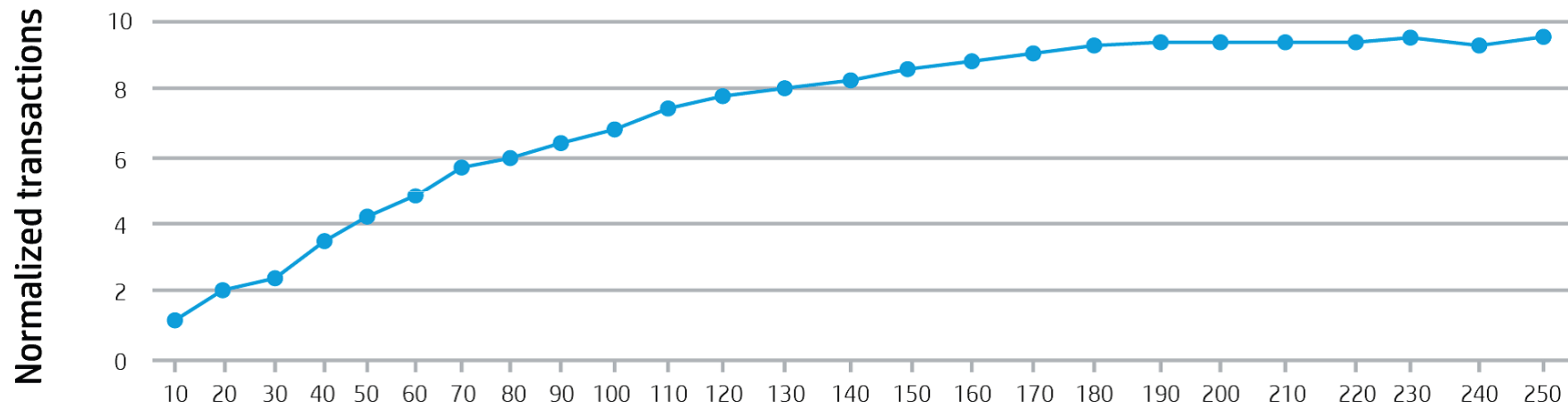

## Number of virtual users



# OLTP rezultati za virtualiziranu okolinu

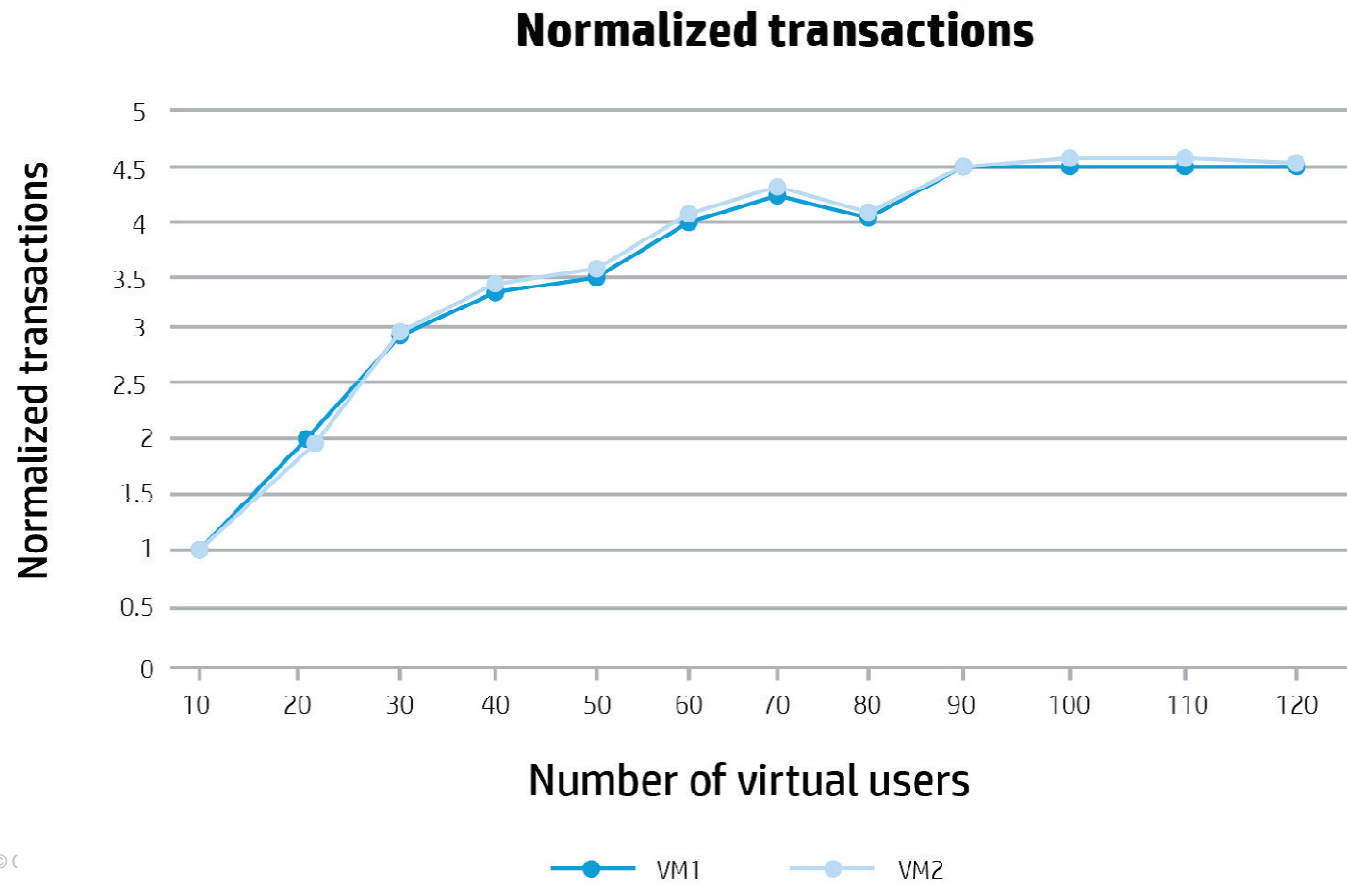

## Performanse kod BI opterećenja

- Testovi I/O propusnosti su rađeni kako bi se ispitale performanse HP 3PAR StoreServ 7450 All-flash Storage Array uređaja prilikom obrade slijednih pristupa sa velikim blokovima.
- Testiranje je ograničeno na fizičku okolinu.
- To nije bilo motivirano bilo kakvim ograničenjem virtualne okoline.
- Veličina blokova → 1MB

1 MB blokovi	Propusnost
Random reads	10.5 GB/s
Sequential reads	10.8 GB/s

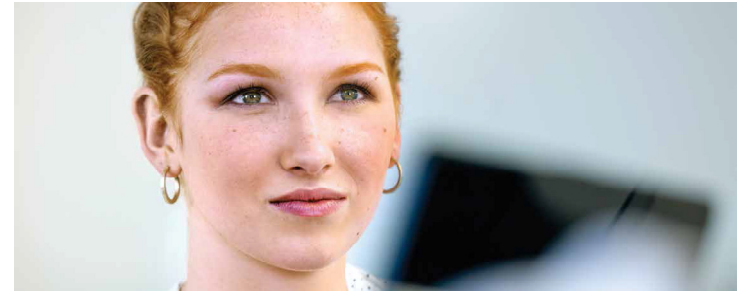

Video: <https://www.youtube.com/watch?v=0ZoFQNyB6cl>